

Ibiza lounge chair

by Eugeni Quitllet

This is the first collection we launched by recovering and manufacturing recycled fishing nets from the Mediterranean Sea because we thrive to build a better future. Eugeni Quitllet was inspired by the idyllic natural surroundings of Ibiza, where he spent his childhood, to design a unique Mediterranean inspired collection. Wave-shaped like pieces that also simulate seashells.



Info

Description

Made from polypropylene and reinforced with fiberglass manufactured by gas injection. Stackable . Available in various colors. Suitable for indoor and outdoor use.

In addition, the “Vondom Revolution” finish means it is made from 100% recycled plastic from the Mediterranean sea.

Weight: 8.51 Kg

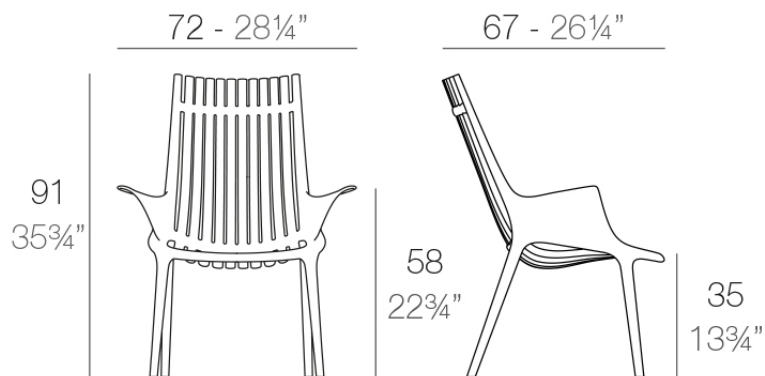

IBIZA Sillón
IBIZA Lounge Chair

Accessories

- **Fabric**

Fabric

Finishes

finishes

BASIC PP
Ref. 65039

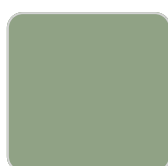

pickle

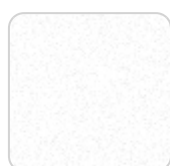

white

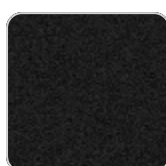

black

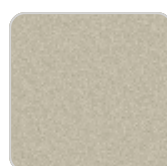

ecru

Available in various colors

VONDOM REVOLUTION
Ref. 65039VR

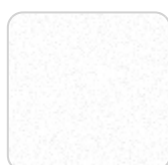

milos

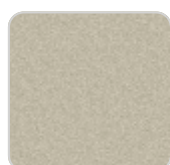

cala



manta

Recycled polypropylene from fishing nets, recycled plastic from the Balearic Islands and bottles collected from our seas.

Ambients

