

Hamptons chaiselongue right section

by Ramón Esteve

Hamptons, the **new collection of designer outdoor furniture** consists of a set of pieces where a careful selection of fabrics and patterns evoke that “lifestyle” where elegance is perceived in the finest details.



Info

Description

Ramón Esteve has designed an elegant modular sofa with a solid aluminium structure, teak details and polished aluminium legs. Its upholstery, devised for outdoor use,

combines weather resistance with the comfort of an indoor fabric. Available in a varied colour palette, it is versatile to suit both outdoor and indoor spaces.

Weight: 24.14 Kg

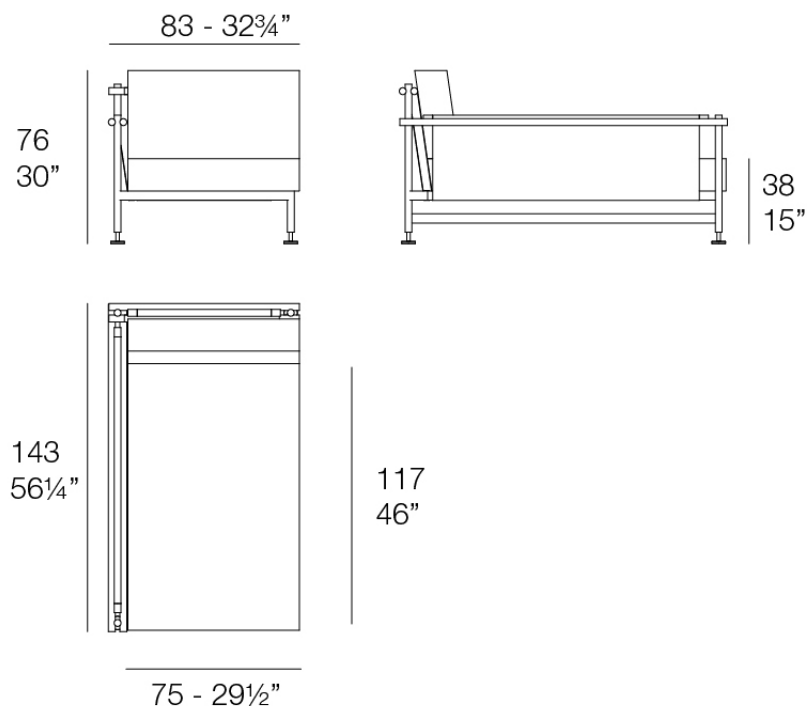

HAMPTONS Chaiselongue Módulo Derecho
HAMPTONS Chaiselongue Right Section

Finishes

finishes

ALUMINIUM

Ref. 54805



white



british gray



traffic gray



black

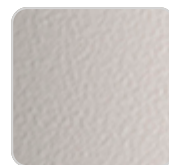

ecru



crema



castoro fiber



cacao



notte blue



modo green



pickle



almond



red



purjai red



melon



mostaza



Lacquered aluminium profile.

fabric

SILVERTEX
Ref. 54805RIB

Vinyl fabric suitable for indoor and outdoor use. Special option for upholstery.

CREVIN
Ref. 54805RIB

Upholstery fabric, that as and natural appearance and can be easy cleaned by washing machines, allowing an easy removal of mildew. Suitable for indoor and outdoor use

CICO
Ref. 54805RIB

Cozy fabric with an elegant look and soft touch.

ACAPULCO
Ref. 54805RIB

Cozy fabric with an elegant look and soft touch.
SIESTA
Ref. 54805RIB

VONDOM

Cozy fabric with an elegant look and soft touch.

IKON

Ref. 54805RIB

Cozy fabric with an elegant look and soft touch.

HERITAGE

Ref. 54805RIB

Outdoor fabrics are waterproof 50% recycled acrylic, 47% acrylic and 3% PE.

SAVANE

Ref. 54805RIB

Outdoor fabrics are waterproof 100% acrylic.

fabric

SILVERTEX

Ref. 54805CO



forest 1224



purjai red 1223

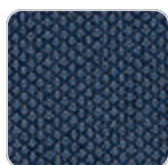

notte blue 1222

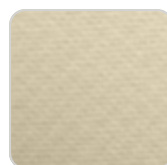

ecru 1221



natural 1220

VONDOM



white 1219



beige 1211



bronze 1214



khaki 1218



steel 1208



taupe 1209



antrachite 1210

Vinyl fabric suitable for indoor and outdoor use. Special option for upholstery.

CREVIN Ref. 54805CO



melon 1304



lemongrass 1303



deep blue 1302



blue 1301

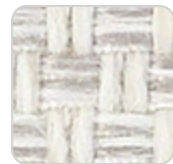

white 1308



steel 1309



taupe 1310



anthracite 1311

Upholstery fabric, that as and natural appearance and can be easy cleaned by

VONDOM

washing machines, allowing an easy removal of mildew. Suitable for indoor and outdoor use

CICO

Ref. 54805TEL



onyx 1705



cranberry 1707



greywacke 1704

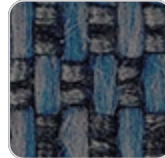

blueberry 1706



sandstone 1703



gravel 1702



limestone 1701

Cozy fabric with an elegant look and soft touch.

ACAPULCO

Ref. 54805TEL



acapulco 1806



acapulco 1801



acapulco 1805



acapulco 1804



acapulco 1803

VONDOM



acapulco 1802

Cozy fabric with an elegant look and soft touch.

SIESTA

Ref. 54805TEL



siesta 1812

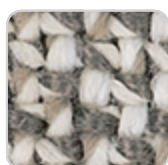

siesta 1811



siesta 1810

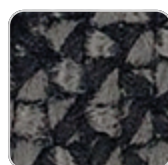

siesta 1813

Cozy fabric with an elegant look and soft touch.

IKON

Ref. 54805TEL



ikon 1834



ikon 1833



ikon 1832



ikon 1835



ikon 1831

VONDOM



ikon 1830

Cozy fabric with an elegant look and soft touch.

HERITAGE

Ref. 54805CO



papyrus 1530



granite 1531

Outdoor fabrics are waterproof 50% recycled acrylic, 47% acrylic and 3% PE.

SAVANE

Ref. 54805CO

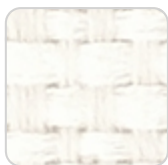

white 1501



tornado 1503



whisper 1502

Outdoor fabrics are waterproof 100% acrylic.

HAMPTONS

VONDOM

Ref. 54805TEL



castor 1412



crema 1411



turquesa 1414

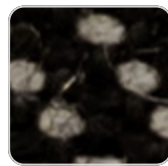

negra 1413

Ambients

