

## Blow planter 100x100x75

by Stefano Giovannoni

**Blow Collection**, designed by **Stefano Giovannoni** for Vondom, comes from the willing to develop a **new family of in&out design products** in tune with the Pillow family but different in typology.



## Info

---

### Description

Pots made of polyethylene resin by rotational moulding. 100% Recyclable. Item suitable for indoor and outdoor use. Available in different finishes.

Weight: 25.08 Kg

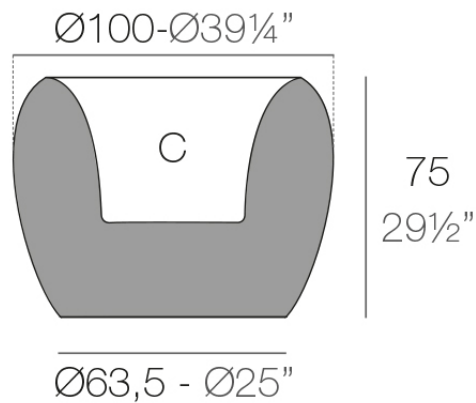

BLOW Macetero 100x75  
BLOW Planter 100x75

C = 104 L  
C =  $27\frac{1}{2}$  gal

## Finishes

---

### finishes

---

BASIC

Ref. 55021A



orange



ice



notte blue



crema



green

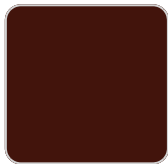

purjai red



white



black



bronze



steel



anthracite



red



khaki



taupe



ecru



# VONDOM

beige



Matt Polyethylene

SELF-WATERING

Ref. 55021R



orange



ice



notte blue



crema

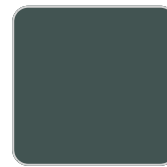

green

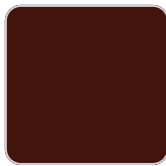

purjai red



white



black



bronze



steel



anthracite



red



khaki



taupe



ecru



# VONDOM

beige



Self-watering system included in all planters except those with basic finish

## LACQUERED

Ref. 55021F



orange



notte blue



crema



purjai red

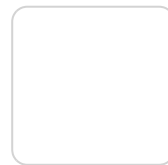

white



black



bronze



steel



anthracite



red



khaki



taupe



ecru



beige

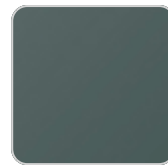

modo green



champany

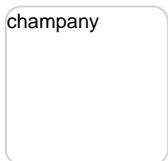

Lacquered Polyethylene

## lighting

---

WHITE LED  
Ref. 55021W



ice



White internally lit unit with LED technology. Available only in matte ice white finish.

RGBW LED  
Ref. 55021L

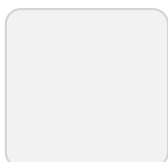

ice



Unit with internal lighting with RGBW LED technology and remote control unit for switching colors. Available only in matte ice white finish. Remote control included.

## RGBW LED DMX Ref. 55021D



Unit with internal lighting with RGBW LED technology and remote control unit for switching colors. Also controlled by DMX-1024 (wireless), enabling communication between one or more products simultaneously via the DMX transmitter (not included). There are two options to choose from: Professional XLR DMX and Home WIFI DMX. (Remote control included).  
Optional battery

## RGBW LED BATTERY Ref. 55021Y



Unit with internal lighting with battery-powered RGBW LED technology. Includes charger and remote control for switching colors and charger. Available only in matte ice white finish.

## RGBW LED DMX BATTERY Ref. 55021DY

# VONDOM

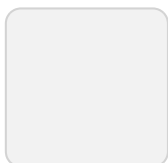

Unit with internal lighting with RGBW LED technology and remote control unit for switching colors. Also controlled by DMX-1024 (wireless), enabling communication between one or more products simultaneously via the DMX transmitter (not included). There are two options to choose from: Professional XLR DMX and Home WIFI DMX. (Remote control included).



## Ambients

---

